



TheraPro HR90

ELECTRONIC RADIATOR CONTROLLER

AutomatikCentret

Strandvejen 42 • Saksild • 8300 Odder
86 62 63 64 • www.automatikcentret.dk
info@automatikcentret.dk

PRODUCT DATA SHEET



OVERVIEW

Honeywell Home TheraPro HR90 is an electronic radiator controller with a modern design and provides features for convenience and energy saving.

It is used as a standalone controller for radiator heating control applications.

For optimized readability of the backlight display, the display position can be adjusted as well. The display is switched On as soon as a button is pressed or the wheel is rotated.

Fast installation due to the simple lock mechanism closing the device at the radiator valve. Up to 3 pre-set standard time programs are selectable.

After the installation, the HR90 operates immediately to the factory set program.

The time program can be individually adapted to the customer's day-to-day routine. Up to 6 setpoints per day and 3 different setpoint temperatures which are changeable provide increased comfort.

Different operating modes and particular day functions can be selected if required:

- Automatic, ECO and Manually
- Holiday, Party and Day off

The particular Day off is a separate daily program which can be activated for special days like public holidays.

Energy saving features:

-With the auto-window function, the radiator valve is closed when ventilating the room.

-In ECO mode, the room temperature is lowered by 3°C.

-Optimised control of the room temperature by start/stop the radiator controller calculates when to open or close the valve in order to achieve the desired room temperature at the set time.

Radiator controller operating parameters are selectable.

Examples:

- Select local language
- Switch backlight display On/Off
- Change sensitivity of the window reaction time
- Valve stroke
- Temperature limitation (lower/upper temperature)
- Temperature offset
- Window function Auto or external window contact
- Child protection (device locking)
- Setup weekday for the valve protection cycle

MAIN FEATURES

- New attractive design out of high quality plastic material and high gloss polished surface
- User friendly because of large, adjustable backlight display with sharp contours, outstanding readability and text display
- Local language selection
- Fast mounting and taking into operation through simple interlocking and 3 pre-programmed time programs
- Fits on the most common radiator valves of the type M30x1,5
- Different operation modes: Holiday, Party, separate time program for particular days
- Additional energy saving features: ECO operation, window function and optimization
- Connection of external wired sensors for reading of room temperature and setpoint value changes, external wired window contact
- Established time program can be copied to further devices
- Anti-theft protection for batteries and device
- Child protection

50088280-001 A

Bedienelemente und Display



SPEZIFICATION

ELECTRICAL DATA

Power supply:	Battery or chargeable batteries
Battery Type:	LR6, AA, AM3 2x Mignon 1,5V Alternativ: 2x Lithium 1,5V 2x NiMH 1,2V chargeable batteries

Display

Backlight display:	Text based display 9 characters 30x26mm (BxH)
---------------------------	--

ENVIRONMENTAL AND STANDARDS

Environmental temperature :	0 +50 °C
Storage temperature:	-20 ...+55 °C
Humidity:	10 ... 90 % relative humidity

For apartments, family houses, business and commercial areas

CERTIFICATION

Standards:	CE Konformität, RoHS
-------------------	----------------------

- 1 Heating period/setback period in hours
- 2 Day of the week 1 ... 7 (Monday ... Sunday).
Displayed only while the time program is being programmed
- 3 Temperature display: e.g. set point temperature (factory setting) or measured temperature, if configured in Parameter 9
- 4 Text display with 9 characters
- 5 Button **OK**: Confirm settings
- 6 Button **PROG**: Select the operating modes, set the time program;
Press button >10 seconds): access to the parameter menu;
Programming: Back to next level up
- 7 Adjustment dial: Change the set point, navigate menu
- 8 Button **AUTO/ECO/MANU**: Change between automatic, ECO and manual mode
In programming mode: Exit (without storing)
- 9 Battery status
- 10 Operation lock
- 11 Symbol for Comfort temperature 1 ☀, Comfort temperature 2 ☀, Setback temperature ☾

TEMPERATURE CONTROL

Internal Sensor

Sensor:	NTC
----------------	-----

MECHANICAL DATA

Dimensions (HxWxD):	60 x 54 x 96 mm
Material:	PC
IP Class:	IP 30
Valve connection:	M30 x 1,5

OPTION

Power Module für external

Power supply:	APS90
Voltage input:	9....24V AC/DC
Vandalism protection:	AVS90
External room Unit:	HCW23
(Sensor/Setpoint):	
External room sensor:	RF20
External window contact:	HCA30
Copy cable 0,5m:	ACC90
Connection cable 2,0m:	ACS90
(ext. Sensor/Window contact)	
Front Dial Chromed:	AFA90
VPE 3pcs	

HR90	EANCODE:	5025121383974
HR90 WE	EANCODE:	5025121383950
HR90EE	EANCODE:	5025121383967

Installation HR90

- 1. Insert Batteries**
2x 1,5V Typ: LR6, AA,AM3

Set language, date and time

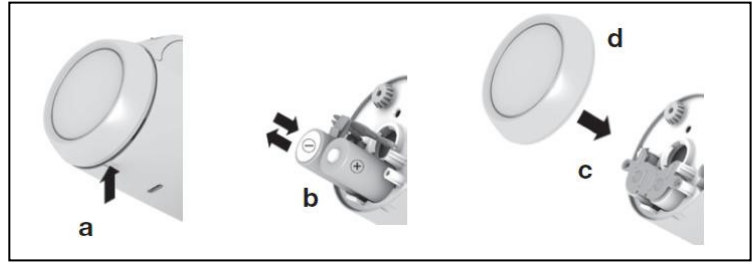

- 2. Remove Thermostat**

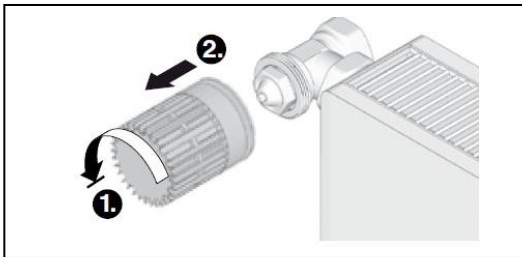

- 4. Put the Valve baseplate on the valve use adaptor if necessary**

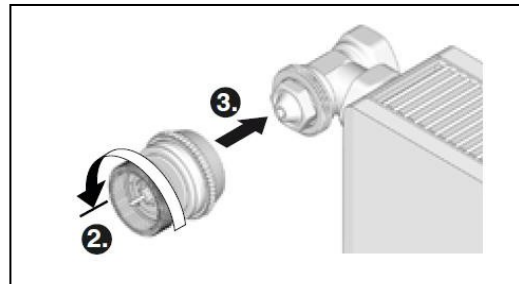

- 3. Remove valve baseplate**



- 5. Connect the valve baseplate with the controller**



READY! HR90 is working with the standard time program

Installation HR90

HR90 wired with external Sensor/Setpoint adjuster HCW23, RF20 and external Window contact

Wiring diagram

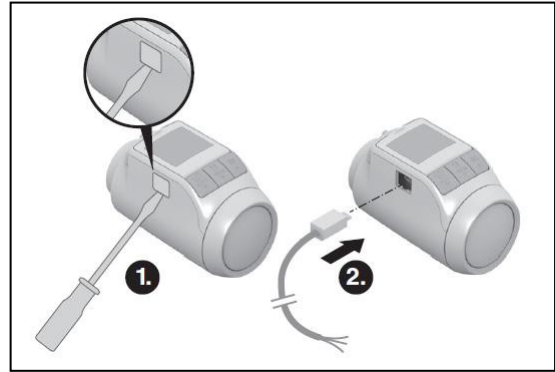
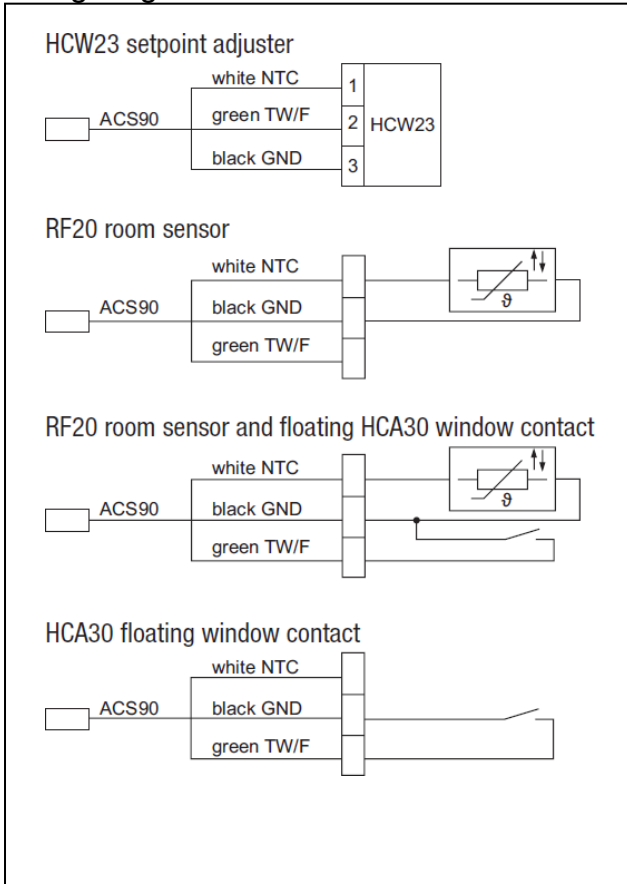

Cable 2m ACS90

Copy time program to other HR90 controllers

If several HR90 radiator controllers are to operate with the same time program, the time program only has to be created at one device (master) and can then be copied to further radiator controllers. The controllers are connected with the cable ACC90

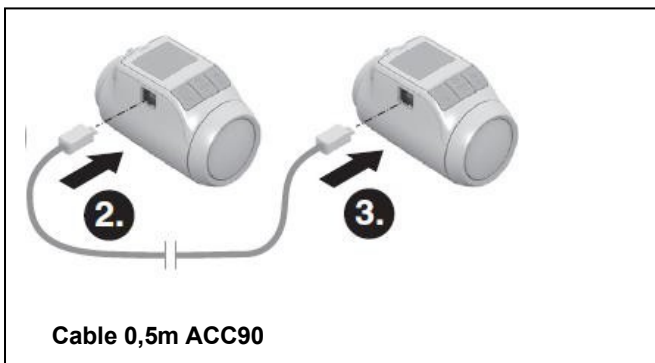

Cable 0,5m ACC90

Options

The radiator controller and the batteries can be secured against stealing by using the supplied screws

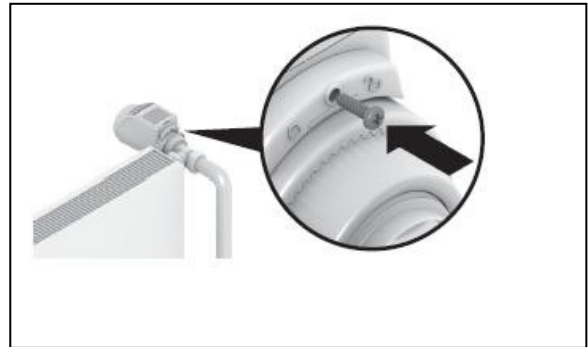
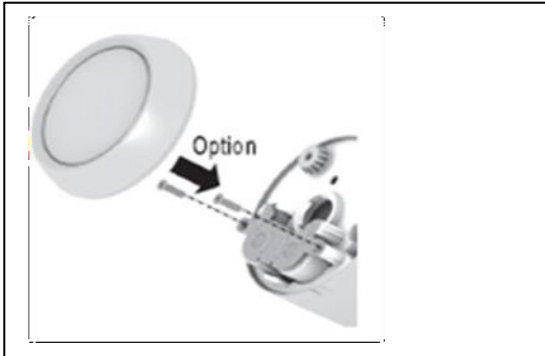

The color of the front cover can be replaced with chromed cover



The display can be fixed with display holder (angle 40°)

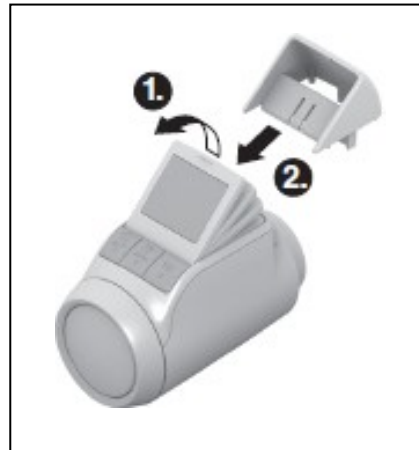

Note: For the various OS numbers HR90/HR90WE and HR90EE the same data are applied