

evohome

Installation Guide

EN

















 **AutomatikCentret**

Strandvejen 42 • Saksild • 8300 Odder
86 62 63 64 • www.automatikcentret.dk
info@automatikcentret.dk



The connected heating controller

Icon key

 evohome Controller	 Single Zone Thermostat (Y87RF)
 evohome Controller Wall Bracket (ATF600)	 Room Temperature Sensor (HCW82)
 evohome Controller Table Stand (ATF800)	 Room Temperature Sensor (HCF82)
 Radiator Controller (HR92)	 Digital Room Thermostat (DTS92)
 Radiator Controller (HR80)	 Wireless Cylinder Thermostat Transceiver (CS92)
 Wireless Relay Box (BDR91)	 Wireless Cylinder Thermostat Strap-on Sensor (CS92)
 Wireless OpenTherm Bridge (R8810)	 Wireless Cylinder Thermostat Insertion Sensor (CS92)
 Underfloor Heating Controller (HCE80 or HCC80)	 Wireless Relay Box (BDR91)
 Mixing Valve Controller (HM80)	

Hot Water Kit (ATF500DHW)

Thanks for choosing **evohome**

evohome means more comfort, and more control of the heating system. It's simple to install and easy to use.

Follow these instructions to set up the **evohome** system. Devices that need to be connected to the mains electricity supply should be installed by a competent person.

Before you start

Make sure you have all the devices you need for your system. If you used our 'Design your **evohome** system' guide, match each device to the room or zones in your plan. It's a good idea to carry out all the mains electrical and other wiring work first.

In this guide

Step 1: Wire up the heating system	3
Step 2: Set up your evohome Controller	9
Step 3: Power up and bind devices	13
Step 4: System test	29
Configuration and modification	37
Appendix	41

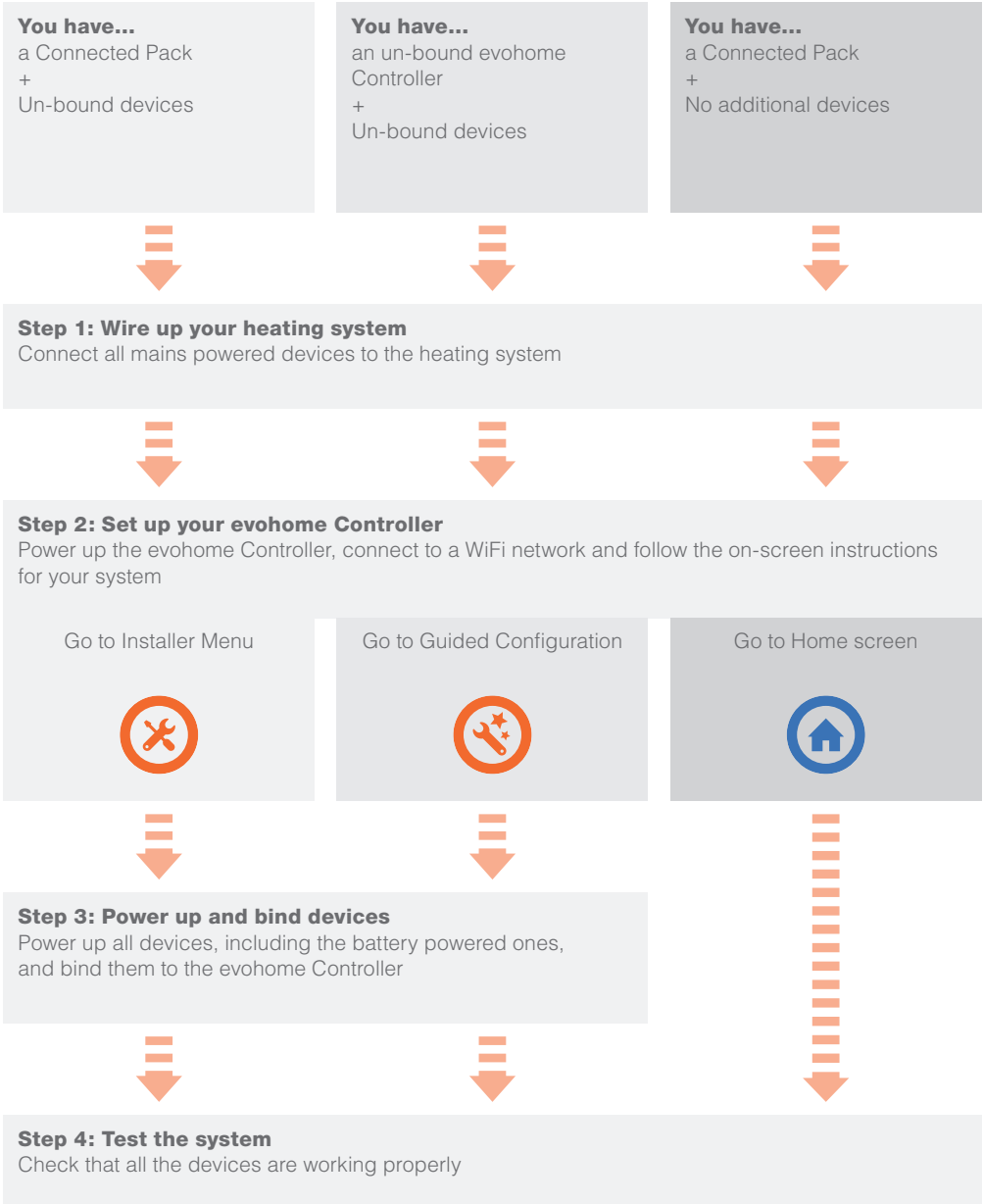

Step 1: Wire up the heating system

evohome communicates using wireless on a robust 868Mhz signal that is unaffected by common remote controls or WiFi.

Some devices need mains power or to be connected to external equipment and it's best to wire up these items first to simplify the binding process later in the setup. The evohome controller will give on screen instructions when these should be powered up.

Before you power up your **evohome** Controller and install the radiator controllers, it's best to install any devices which are mains powered or need specific installation.

In this section

Wireless Relay Box (BDR91)	4
Wireless Cylinder Thermostat (CS92)	5
Mixing Valve Controller (HM80), Underfloor Heating Controller (HCE80/HCC80), Opentherm Bridge (R8810)	7

Wireless Relay Box (BDR91)



Turn off at mains and isolate the supply before starting



If you're fitting a Wireless Relay Box (BDR91) to your boiler, zone valve or Sundial valve

- 1 Mount the Wireless Relay Box on a non-metal surface at least 30cm from your boiler, other wireless devices or metal objects
- 2 Release the clip on the bottom to open the front cover
- 3 Follow the wiring diagram (see Appendix: Figures 5-10) to connect the Wireless Relay Box to your boiler's thermostat terminals, zone valve or sundial valve, and to the mains electricity supply
- 4 Replace the cover

Refer to boiler instruction to locate the room thermostat terminals, determine if the boiler required a permanent live supply.

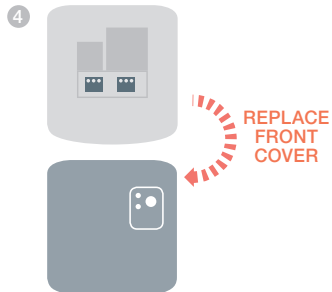
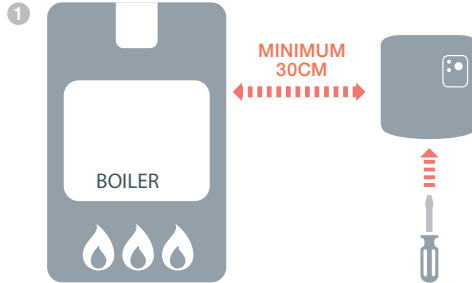

Wireless Cylinder Thermostat (CS92)



If you're fitting a Wireless Cylinder Thermostat (CS92)

You will need to install the CS92 Transceiver and only one of the two sensors (CS92 Strap-on Sensor or CS92 Insertion Sensor).



To fit the CS92 Strap-on Sensor

- 1 Cut away a section of cylinder insulation slightly larger than the sensor unit
- 2 Clean the exposed cylinder surface
- 3 Place the sensor on the cylinder surface and secure it using the fixing strap – cut the strap to size if it's too long
- 4 Install the CS92 Transceiver in a suitable location close enough for the cable from the sensor to reach
- 5 Connect the cable from the sensor to the CS92 Transceiver

Position the sensor from one quarter to a third of the way up the cylinder.

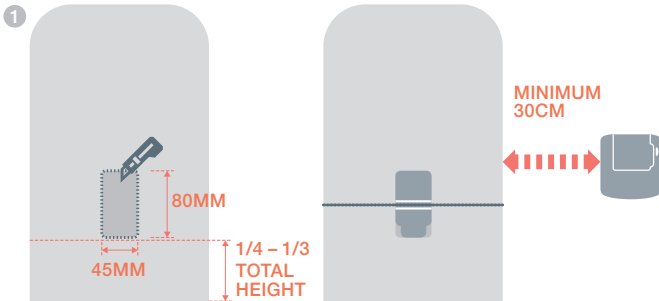

Wire to CS92 Transceiver

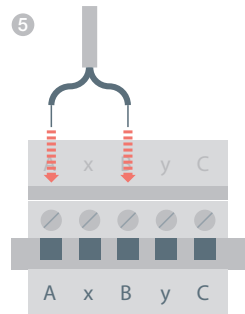

Wireless Cylinder Thermostat (CS92) *continued*



If this sensor is used in an unvented hot water storage application, the cylinder manufacturer's instructions must be followed to ensure compliance with all safety regulations.

If in doubt, contact the cylinder manufacturer.



To fit the CS92 Insertion Sensor

- ① Fit in the cylinder immersion well with suitable fittings to provide strain relief and prevent accidental removal
- ② If the sensor doesn't fit tightly in the immersion well fill the space with heat-conductive compound to ensure maximum heat transfer
- ③ Install the CS92 Transceiver in a suitable location close enough for the cable from the sensor to reach
- ④ Connect the cable from the sensor to the CS92 Transceiver.

The wires are polarity free, so can be connected in any order. Provide appropriate strain relief to this end of the sensor cable as well.

Wire to CS92 Transceiver

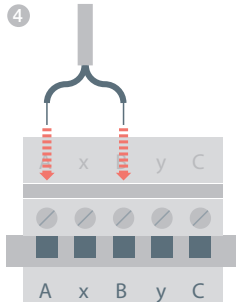

Mixing Valve Controller (HM80), Underfloor Heating Controller (HCE80/HCC80), OpenTherm Bridge (R8810)



If you're fitting a Mixing Valve Controller (HM80), Underfloor Heating Controller (HCE80/HCC80), OpenTherm Bridge (R8810)



Refer to the installation instructions supplied with each device

Step 2: Set up your evohome Controller

The **evohome** Controller has a guided configuration process to help you set up the zones for a single type of system. For mixed systems (i.e. Under Floor Heating zones plus Radiator zones) use Guided Configuration for the larger system then “Add Zones” in the installer menu.

To add a stored hot water system use the guided configuration Stored Hot Water option in the installer menu.

The following instructions cover the full configuring process for a zone, but if you are using Guided Configuration your **evohome** Controller will give you on-screen instructions to bind the other components to the **evohome** Controller – just follow the bind instruction for each device in this manual.

In this section

Powering up your evohome Controller	10
Language selection and WiFi configuration	11
Set-up the evohome controller for your system	12

Powering up your **evohome** Controller



Your **evohome** Controller comes with *rechargeable batteries which are pre-charged allowing you to set-up the system while off the table stand or wall bracket.

Place the **evohome** Controller on the table stand or wall bracket for normal use.

*Only use the AA rechargeable batteries provided.

First, power up the **evohome** Controller

- 1 Remove the cover, remove the battery tab and replace the cover.
- 2 Place it on the table stand or wall bracket
- 3 Once the batteries are fully charged, the **evohome** Controller can be easily removed from the table stand or wall bracket for ease of programming. After 30 minutes the **evohome** Controller will emit a beep to indicate that it should be replaced on the stand or wall bracket

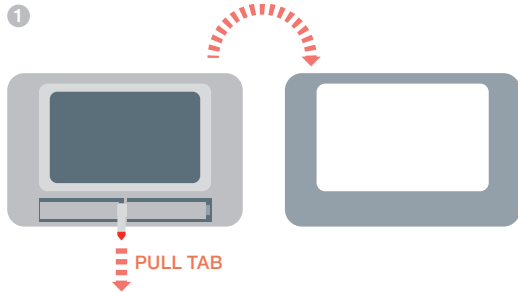

Language selection and WiFi configuration



If you don't have the WiFi network details, or the homeowner doesn't require remote access you can skip the WiFi configuration and proceed with setting up the heating system.

WiFi can be configured later in the **SETTINGS > WiFi SETTINGS** menu.

Select a language for the **evohome** controller and connect to a WiFi network

- 1 Select a language for the **evohome** controller user interface
- 2 Follow the on-screen instructions to connect to a WiFi network. This enables automatic setting of the date and time for your location, as well as enabling remote connectivity via an Apple or Android Smartphone.
 - **To configure WiFi you will need the home WiFi network password**
- 3 Instruct the homeowner / user to visit **www.mytotalconnectcomfort.com** to create an account, register the **evohome** Controller and download the app.



Select your store

}



Get the App

- **To create an account and register the evohome Controller the homeowner will need the MAC ID and CRC which can be found:**
 - On a label behind the front cover of the **evohome** Controller
 - on screen during the WiFi set-up
 - in the **SETTINGS > WiFi SETTINGS** menu after set-up has been completed



MAC ID

CRC

Set-up the **evohome** controller for your system

Now choose the correct option for the system you're installing:



For a **Connected Pack*** and NO additional un-bound devices we recommended pressing 'Home' – then go to "Step 4: System test" on page 29.



For a **Connected Pack***, PLUS additional un-bound devices we recommended pressing 'Installation Menu' to add the un-bound devices and follow "Step 3: Power up and bind devices" on page 13.



For an un-bound **evohome** Controller, PLUS additional un-bound devices we recommended pressing 'Guided Configuration' to add the un-bound devices and follow "Step 3: Power up and bind devices" on page 13.

* A Connected Pack contains devices which are already bound to the **evohome** Controller. Choosing "Guided Configuration" will delete the binding from **evohome** Controller and will require to be bound again.

The Wireless Relay Box (BDR91) in a Connected Pack is bound as a boiler controller. If you intend to use it as a Zone Valve or S-Plan/Y-Plan (Sundial) Valve controller the binding must be cleared from the Wireless Relay Box first.

Step 3: Power up and bind devices

If you bought a Connected Pack only — your devices are already bound. Go to Step 4.

If you bought an unbound evohome Controller, plus other un-bound devices and are using 'Guided Configuration' follow the instructions on your evohome Controller screen and use this section to put the devices into binding mode.

If you bought a Connected Pack, plus other un-bound devices, you need to power up all devices and then bind them to the evohome Controller using the 'Installation Menu'. It may be easier to power up and bind some devices while they're close to the evohome Controller – you can install them in their assigned zones later.

Follow the instructions for the device(s) you're going to bind. When you bind a device to the evohome Controller the devices permanently store the connection and there should never be a need to rebind them again – even after a power cut.

In this section

Radiator Controllers (HR92)	14
Wireless Cylinder Thermostat (CS92)	16
Wireless Relay Box (BDR91) to control a Boiler	18
OpenTherm Bridge (R8810)	19
Wireless Relay Box (BDR91) to control a Zone Valve	20
Radiator Controller (HR80)	22
Underfloor Heating Controller (HCE80 or HCC80)	24
Mixing Valve Controller (HM80)	27

Radiator Controllers (HR92)



evohome
Controller

If you are NOT following GUIDED CONFIGURATION follow these steps on your **evohome** Controller display first:





1. Press and hold 'Settings' ⚙️ for 3 seconds
2. Press the green tick ✓
3. Press ADD ZONE
4. Type a name for the new zone and press the green tick ✓
5. Press RADIATOR VALVE
6. If you want to control the zone temperature with the **evohome** Controller (which needs to be located in that zone) press YES, otherwise press NO.

You must repeat these steps for each radiator controller.



Power up and bind Radiator Controllers (HR92) – Your **evohome** Zone Kit

Bind the Radiator Controllers (HR92)

- 1 Remove the circular top cover
- 2 Open the battery clip and insert the AA batteries supplied
- 3 Close the clip and replace the cover
- 4 Press the  button once – it should say UNBOUND
- 5 Press and hold the  button for a further 5 seconds until it says BIND
- 6 Press the  button once – it should say BINDING
- 7 You should receive a SUCCESS message on the **evohome** Controller (if not go back and re-bind)
- 8 The name of the allocated zone should appear on the HR92 display when you press the  button
- 9 Either press the green tick ✓ to add another radiator to the zone. Or press the red cross ✗ if you don't need to add another radiator to the zone

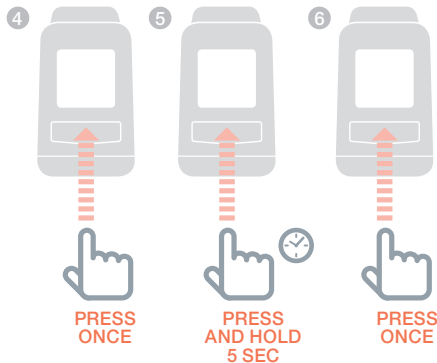
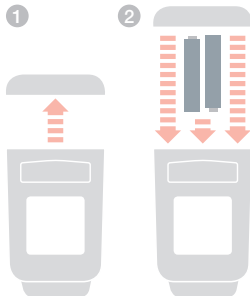



Install the Radiator Controllers (HR92)

- 1 Locate the room (zone) for the radiator controller
- 2 Slide the locking mechanism to the unlock position
- 3 Remove the adaptor from the bottom of the controller
- 4 Unscrew the black wheel fully anti-clockwise
- 5 Remove any existing control on the radiator valve
- 6 Screw the white end of the adaptor on to the radiator valve
- 7 Push the controller fully on to the adaptor with the screen facing towards you
- 8 Slide the locking mechanism to the locked position

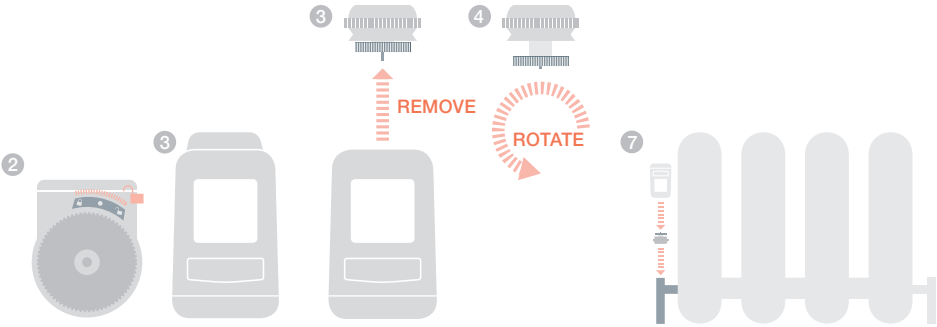

Wireless Cylinder Thermostat (CS92)



**evohome
Controller**

If you are NOT following GUIDED CONFIGURATION follow these steps on your **evohome** Controller display first:

1. Press and hold "Settings" ⚙️ for 3 seconds
2. Press the green tick
3. Select GUIDED CONFIGURATION
4. Press STORED HOT WATER CONFIGURATION
5. Press the green tick

To control a stored hot water system you first need to bind the CS92 Transceiver and then bind the Wireless Relay Box (BDR91) that is controlling the hot water valve.



Power up and bind the CS92 Transceiver

On the CS92 Transceiver

- 1 Remove the CS92 Transceiver cover, pull out the battery tab and replace the cover
- 2 On the CS92 Transceiver press and hold the button for 5 seconds. The green light should come on and the red light should flash
- 3 Press the button again
- 4 You should receive a SUCCESS message on the **evohome** Controller (if not go back and re-bind)
- 5 Choose the correct hot water valve type for the system you're installing and follow the on screen instructions

1

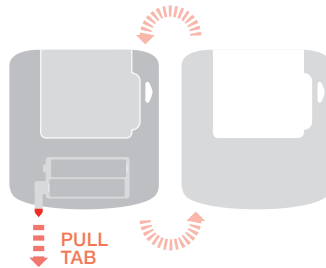

2

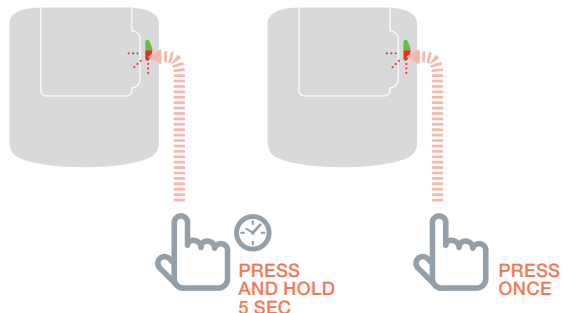



You may need to refer to the wiring diagrams in the Appendix



The Wireless Relay Box in a Connected Pack is bound as a boiler controller. If you intend to use it as a S-Plan/Y-Plan Valve controller the binding must be cleared from the Wireless Relay Box first – as described in step 1.



To bind the Wireless Relay Box (BDR91) controlling the hot water valve

- 1 On the Wireless Relay Box, press and hold the button for 15 seconds (until the red LED blinks rapidly) to clear any previous binding data
- 2 Press and hold the button again for 5 seconds (until the red LED blinks slowly)
- 3 On the **evohome** Controller press the green bind button 
- 4 You should receive a SUCCESS message on the **evohome** Controller (if not go back and re-bind)

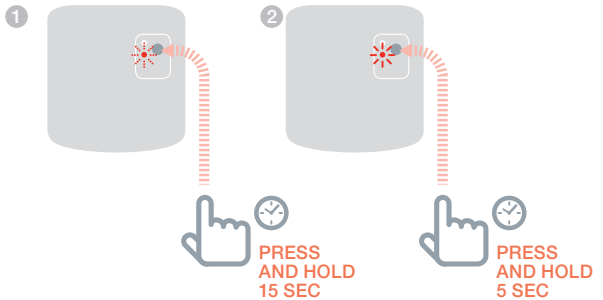

Wireless Relay Box (BDR91) to control a boiler



evohome
Controller

If you are NOT following GUIDED CONFIGURATION follow these steps on your **evohome** Controller display first:

1. Press and hold 'Settings' ⚙️ for 3 seconds
2. Press the green tick
3. Press SYSTEM DEVICES
4. Press BOILER CONTROL
5. Press BOILER RELAY



Power up and bind a Wireless Relay Box (BDR91) to control a boiler

Make sure the Wireless Relay Box (BDR91) is wired to the boiler and powered up.

To bind the Relay Box

- 1 Press and hold the button for 15 seconds (until the red LED blinks rapidly) to clear any previous binding data
- 2 Press and hold the button again for 5 seconds (until the red LED blinks slowly)
- 3 On the **evohome** Controller press the green bind button
- 4 You should receive a SUCCESS message on the **evohome** Controller (if not go back and re-bind)

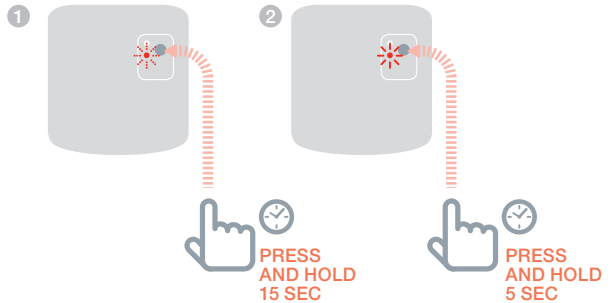

OpenTherm Bridge (R8810)



evohome
Controller

If you are NOT following GUIDED CONFIGURATION follow these steps on your **evohome** Controller display first:

1. Press and hold 'Settings' ⚙️ for 3 seconds
2. Press the green tick
3. Press SYSTEM DEVICES
4. Press BOILER CONTROL
5. Press OPENTHERM BRIDGE



Power up and bind an OpenTherm Bridge (R8810) to control an OpenTherm boiler

Make sure the OpenTherm Bridge (R8810) is wired to the boiler and powered up.

To bind the OpenTherm Bridge

- 1 Press and hold the button for 15 seconds (until the red LED blinks rapidly) to clear any previous binding data
- 2 Press and hold the button again for 5 seconds (until the red LED blinks slowly)
- 3 On the **evohome** Controller press the green bind button
- 4 You should receive a SUCCESS message on the **evohome** Controller (if not go back and re-bind)

1



PRESS
AND HOLD
15 SEC

2





PRESS
AND HOLD
5 SEC

Wireless Relay Box (BDR91) to control a Zone Valve



evohome
Controller

If you are NOT following GUIDED CONFIGURATION follow these steps on your **evohome** Controller display first:

1. Press and hold "Settings" ⚙️ for 3 seconds
2. Press the green tick 
3. Press ADD ZONE
4. Type a name for the new zone and press the green tick 
5. Press ZONE VALVES



All of the remote room sensors will automatically exit from their binding menu after a short period.



Power up and bind a Wireless Relay Box (BDR91) to control a Zone Valve

Make sure the Wireless Relay Box (BDR91) is wired to the Zone Valve and powered up.

If you want to control the zone temperature with the **evohome** Controller (the **evohome** Controller needs to be located in that zone) press YES, otherwise press NO and bind a sensor – either Digital Room Thermostat (DTS92), Single Zone Thermostat (Y87RF), or Room Temperature Sensor (HCW82/HCF82).



To bind the Digital Room Thermostat (DTS92)

- 1 Press and hold the power button  for 2 seconds to put the unit into standby
- 2 Press the up and down arrows together for 3 seconds – it should say INst
- 3 Press the down arrow – it should say COnt
- 4 Press the up arrow three times – it should say CLr
- 5 Press the power button once to clear any previous binding data
- 6 Press the up arrow – it should say COnt
- 7 Press the power button once to send the binding signal to the **evohome** Controller
- 8 You should receive a SUCCESS message on the **evohome** Controller (if not go back and re-bind)



To bind the Single Zone Thermostat (Y87RF)

- 1 Press and hold on the left touch zone (just below and to the left of the display) for approximately 10 seconds until a flashing 'Bo' is displayed
- 2 Turn the dial clockwise until a flashing 'Co' is displayed
- 3 Press the left touch zone once to send the binding signal to the **evohome** Controller
- 4 You should receive a SUCCESS message on the **evohome** Controller (if not go back and re-bind)



To bind the Room Temperature Sensor (HCW82 or HCF82)



- 1 Press the bind button on the bottom right hand corner of the unit once. The red LED light will flash
- 2 You should receive a SUCCESS message on the **evohome** Controller (if not go back and re-bind)

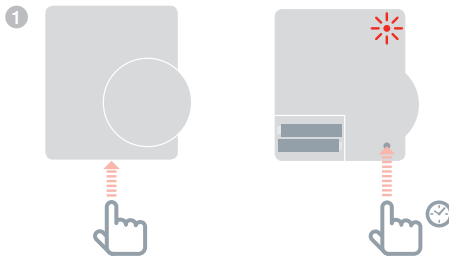



The Wireless Relay Box in a Connected Pack is bound as a boiler controller. If you intend to use it as a Zone Valve controller the binding must be cleared from the Wireless Relay Box first.

Then, on the Wireless Relay Box (BDR91)

- 1 Press and hold the button for 15 seconds (until the red LED blinks rapidly) to clear any previous binding data
- 2 Press and hold the button again for 5 seconds (until the red LED blinks slowly)
- 3 On the **evohome** Controller press the green bind button 
- 4 You should receive a SUCCESS message on the **evohome** Controller (if not go back and re-bind)

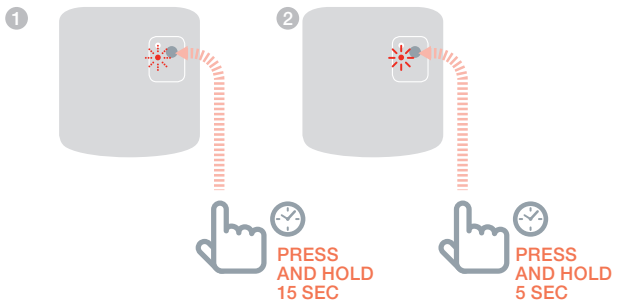

Radiator Controller (HR80)



evohome
Controller

If you are NOT following GUIDED CONFIGURATION follow these steps on your **evohome** Controller display first:

1. Press and hold "Settings" ⚙️ for 3 seconds
2. Press the green tick 
3. Press ADD ZONE
4. Type a name for the new zone and press the green tick 
5. Press RADIATOR VALVE



Power up and bind a Radiator Controller (HR80)

If you want to control the zone temperature with your **evohome** Controller (the **evohome** Controller needs to be located in that zone) press YES, otherwise press NO and bind the sensor.

On the HR80, you need to bind the sensor and actuator separately

- ① Power up the Radiator Controller (see HR80 instructions)

To bind the sensor

- ② Turn release clips on each side of the Radiator Controller to remove the bottom plate
- ③ On the underside of the Radiator Controller press the recessed bind button
- ④ The Radiator Controller screen should briefly show a flashing RF icon (📶) then SYNC when successful. The **evohome** Controller will also show if binding was successful (if not go back and re-bind)

②

SIDE VIEW



③

BOTTOM VIEW

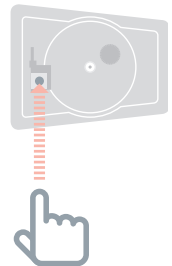

To bind the actuator

- 5 Press the bind button on the Radiator Controller (if there are multiple HR80's in the zone, do this to all of them). The screen should show a flashing RF icon (📶)
- 6 On the **evohome** Controller press the green bind button (→) (←)
- 7 Check that (all) the Radiator Controllers display SYNC. If a Radiator Controller does not display SYNC and the flashing RF icon (📶) remains, press back on the **evohome** Controller and press the green bind button (→) (←) again
- 8 Press the next arrow on the **evohome** Controller

5 BOTTOM VIEW

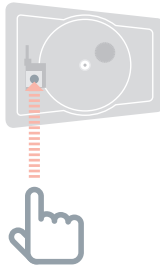



Underfloor Heating Controller (HCE80 or HCC80)



evohome Controller

If you are NOT following GUIDED CONFIGURATION follow these steps on your **evohome** Controller display once the underfloor heating controller and sensors have been fitted:

1. On the **evohome** Controller press and hold "Settings"  for 3 seconds
2. Press the green tick 
3. Press ADD ZONE
4. Type a name for the new zone and press the green tick 
5. Press UNDERFLOOR HEATING
6. You need to install a sensor (HCW82, HCF82, DTS92) in each zone controlled by the underfloor heating controller and bind it to the **evohome** Controller.

You need to repeat this process for every zone that uses underfloor heating.



Make sure the zone you're adding on the **evohome** Controller corresponds to the correct underfloor heating zone.





Power up and bind an Underfloor Heating Controller (HCE80 or HCC80)

If you want to control the zone temperature with your **evohome** Controller (the **evohome** Controller needs to be located in that zone) press YES, otherwise press NO and bind a sensor – either Digital Room Thermostat (DTS92), Single Zone Thermostat (Y87RF), or Room Temperature Sensor (HCW82/HCF82)



To bind the Digital Room Thermostat (DTS92)

- 1 Press and hold the power button  for 2 seconds to put the unit into standby
- 2 Press the up and down arrows together for three seconds – it should say INst
- 3 Press the down arrow – it should say COnT
- 4 Press the up arrow three times – it should say CLr
- 5 Press the  once to clear any previous binding data
- 6 Press the up arrow – it should say COnT
- 7 Press the  once to send the binding signal to the **evohome** Controller
- 8 You should receive a SUCCESS message on the **evohome** Controller (if not go back and re-bind)



To bind the Single Zone Thermostat (Y87RF)

- 1 Press and hold on the left touch zone (just below and to the left of the display) for approximately 10 seconds until a flashing 'Bo' is displayed
- 2 Turn the dial clockwise until a flashing 'Co' is displayed
- 3 Press the left touch zone once to send the binding signal to the **evohome** Controller
- 4 You should receive a SUCCESS message on the **evohome** Controller (if not go back and re-bind)



All of the remote room sensors will automatically exit from their binding menu after a short period.



To bind the Room Temperature Sensor (HCW82 or HCF82)



- 1 Press the bind button on the bottom right hand corner of the unit once. The red LED light will flash
- 2 You should receive a SUCCESS message on the **evohome** Controller (if not go back and re-bind)

1

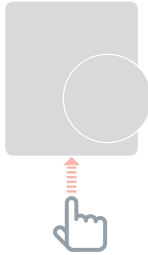

CONTINUED ON NEXT PAGE

Underfloor Heating Controller (HCE80 or HCC80) *continued*



There are two versions of HCE80/HCC80, newer versions have a simplified single stage bind process while older versions have a two stage bind process.

Note the colour of the flashing zone light (GREEN or RED) and follow the instructions for that version. Put a tick next to the version for future reference.



Then on the underfloor controller

- 1 Press and hold the bind button  until the bind light turns solid YELLOW and the zone number light flashes (either GREEN or RED).

Follow the instructions below depending on which colour the zone number light is flashing:





If the zone light is flashing GREEN (single stage bind):

- 2 On the **evohome** Controller, press the green bind button .
- 3 When the zone light turns solid YELLOW the binding is successful for the zone
- 4 Press forward on the **evohome** Controller to complete the binding for this zone

If you are binding more zones repeat the process from the sensor binding step on the previous page, then press the bind button  **twice** on the Underfloor Heating Controller - The GREEN light will flash on the next zone.



If the zone light is flashing RED (two stage bind):

- 2 On the **evohome** Controller, press the green bind button .
- 3 When the message is received the zone light will turn solid RED
- 4 Press the back arrow on the **evohome** Controller
- 5 Press the bind button  on the Underfloor Heating Controller – the zone light should flash GREEN
- 6 On the **evohome** Controller, press the green bind button .
- 7 When the zone light turns solid GREEN the binding is successful for the zone
- 8 Press forward on the **evohome** Controller to complete the binding for this zone

If you are binding more zones repeat the process from the sensor binding step on the previous page, then press the bind button  **once** on the Underfloor Heating Controller - The RED light will flash on the next zone.

Mixing Valve Controller (HM80)



evohome Controller

If you are NOT following GUIDED CONFIGURATION follow these steps on your **evohome** Controller display once the Mixing Valve Controller and sensor have been installed:

1. On the **evohome** Controller press and hold "Settings" ⚙️ for 3 seconds
2. Press the green tick 
3. Press ADD ZONE
4. Type a name for the new zone and press the green tick 
5. Press MIXING VALVE
6. If you want to control the zone temperature with your **evohome** Controller (the **evohome** Controller needs to be located in that zone) YES, otherwise press NO and bind the sensor.



Power up and bind a Mixing Valve Controller (HM80)

A Mixing Valve Controller should only be fitted by a qualified fitter. Unless you're using the **evohome** Controller as a sensor, you need to install a sensor (DTS92, Y87RF, HCW82 or HCF82) before binding the controller to the **evohome** Controller.



To bind the Digital Room Thermostat (DTS92)

- 1 Press and hold the power button for 2 seconds to put the unit into standby
- 2 Press the up and down arrows together for three seconds – it should say INst
- 3 Press the down arrow – it should say COnt
- 4 Press the up arrow three times – it should say CLr
- 5 Press the power button once to clear any previous binding data
- 6 Press the up arrow – it should say COnt
- 7 Press the power button once to send the binding signal to the **evohome** Controller
- 8 You should receive a SUCCESS message on the **evohome** Controller (if not go back and re-bind)



To bind the Single Zone Thermostat (Y87RF)

- 1 Press and hold on the left touch zone (just below and to the left of the display) for approximately 10 seconds until a flashing 'Bo' is displayed
- 2 Turn the dial clockwise until a flashing 'Co' is displayed
- 3 Press the left touch zone once to send the binding signal to the **evohome** Controller
- 4 You should receive a SUCCESS message on the **evohome** Controller (if not go back and re-bind)



All of the remote room sensors will automatically exit from their binding menu after a short period.

CONTINUED ON NEXT PAGE

Mixing Valve Controller (HM80) *continued*



To bind the Room Temperature Sensor (HCW82 or HCF82)

- 1 Press the bind button on the bottom right hand corner of the unit once. The red LED light will flash
- 2 You should receive a SUCCESS message on the **evohome** Controller (if not go back and re-bind)

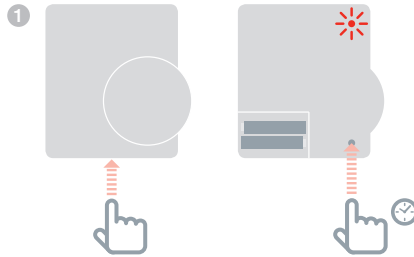

Then on the Mixing Valve Controller

- 1 Press and hold both buttons on the Mixing Valve Controller for 4 seconds until the red light flashes
- 2 On the **evohome** Controller press the green bind button 
- 3 Press the next arrow on the **evohome** Controller

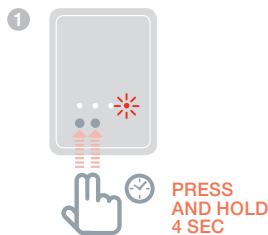

Still want to control the Boiler?

A Mixing Valve Controller will not provide a heat demand to the boiler.

If you do want this zone to provide a heat demand simply change the heating type from 'MIXING VALVE' to 'ZONE VALVES' once the Mixing Valve controller is bound.

There's no need to re-bind any device – The Mixing Valve Controller will still operate as intended and the **evohome** Controller will send the heat demand to the boiler.

Step 4: System test

Now that all the devices are bound to your **evohome** Controller and installed in their final locations, check that the system works properly and that all the devices are responding to commands from the **evohome** Controller.

You can perform a simple functional check of the heating system by overriding the temperature of each zone to their minimum and maximum while listening for a response from the radiator (or zone) controllers and boiler. To save power the battery devices only communicate with the **evohome** Controller every four minutes therefore the system may not respond immediately to a manual temperature change.

In this section

Advanced RF communication check

Mains Powered Wireless Devices

Battery Powered Wireless Devices

30

30

31

Advanced RF communication check



To save power the battery devices only communicate with the **evohome** Controller every four minutes therefore the system may not respond immediately to a manual change.

To check the RF signal strength between the wireless devices and the **evohome** Controller go to RF COMMS CHECK in the **evohome** Controller Installer Menu and test each wireless device.

- 1 On the **evohome** Controller press and hold 'Settings' for 3 seconds
- 2 Press the green tick 
- 3 Press RF COMMS CHECK
- 4 Choose the devices you want to test

Mains Powered Wireless Devices

Mains powered devices do not need to be put into test mode and will automatically respond to the test message sent from the **evohome** Controller:



Wireless Relay Box (BDR91)

- The Relay Box will flash the red LED from 1 flash (poor) to 5 flashes (excellent) – no flashing means the Relay Box has not received a test signal from the **evohome** Controller



Underfloor Heating Controller (HCE80/HCC80)





- The Underfloor Heating Controller will flash the green LED for the zone you are testing from 1 flash (poor) to 5 flashes (excellent) – no flashing means the Underfloor Heating Controller has not received a test signal from the **evohome** Controller

Battery Powered Wireless Devices

Battery powered devices need to be put into test mode to send and receive a test signal:



Radiator Controller (HR92)

- 1 Press the  button, the zone name is displayed
- 2 Press and hold the  button again for 5 seconds, the display should say BIND
- 3 Turn the dial to display RF CHECK
- 4 Press the  button, the display should flash CHECKING
- 5 Press the  button again, the display should flash SIGNAL and will display a signal strength bar and a rating from 1 (poor) to 5 (excellent) – 0 means the Radiator Controller has not received a test signal from the **evohome** Controller.
- 6 To exit test mode turn the dial to exit and press the  button. It will also exit automatically after 10 minutes.

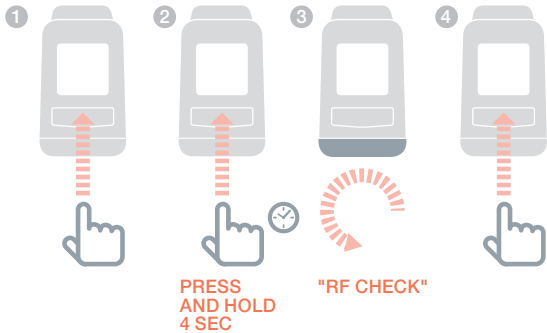

Advanced RF communication check *continued*



Radiator Controller (HR80)

- 1 Separate the Radiator Controller from the adaptor on the radiator
- 2 Turn the adjustment dial clockwise (approx two full rotations) until TEST is displayed

The **evohome** Controller will display the signal strength (poor to excellent) – nothing on the **evohome** Controller display means the Radiator Controller has not received a test signal from the **evohome** Controller.

- 3 To exit test mode remove and reinsert the batteries from the Controller. It will exit automatically after 5 minutes.

2

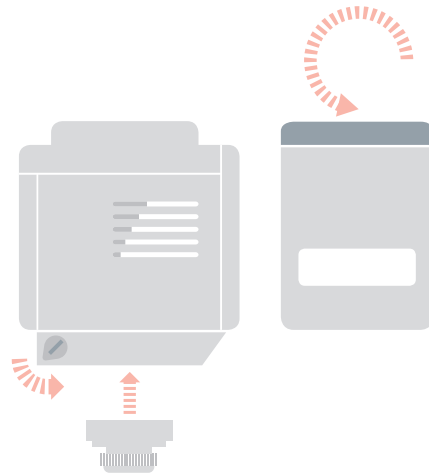



Digital Room Thermostat (DTS92)

- 1 Put the Room Thermostat into standby mode 
- 2 Press up and down together for 3 seconds
- 3 Press down once, the display should say CONT
- 4 Press down for 3 seconds, the display should say TEST
- 5 Press down for 3 seconds, the display should say SS

The **evohome** Controller will display the signal strength (poor to excellent) and the Room Thermostat will display a signal strength rating from 1 (poor) to 5 (excellent) – 0 means the Room Thermostat has not received a test signal from the **evohome** Controller.

- 6 To exit test mode, press off on Room Thermostat for 5 seconds. It will exit automatically after 10 minutes.

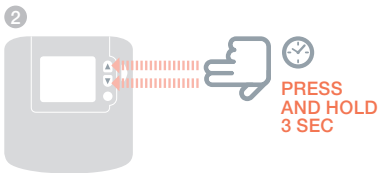

Advanced RF communication check *continued*



Room Temperature Sensor (HCF82 or HCW82)



- 1 Remove the cover from the sensor
- 2 Press and hold the bind button for approximately 30 seconds until the red LED goes off
- 3 The red LED will flash each time it sends a test message

The **evohome** Controller will display the signal strength (poor to excellent) – no flashing means the Temperature Sensor has not received a test signal from the **evohome** Controller.

- 4 To exit test mode, press the bind button on the Temperature Sensor. It will exit automatically after 5 minutes.

1

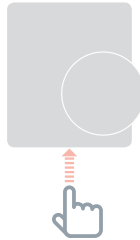

2

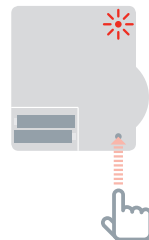

PRESS
AND HOLD
30 SEC



Wireless Cylinder Thermostat (CS92A)

- 1 Press the button on the Cylinder Thermostat transceiver for 5 seconds
- 2 The green light should come on. If it doesn't, reinsert the batteries and try again

The **evohome** Controller will display the signal strength (poor to excellent) and the transceiver should flash the red LED from 1 flash (poor) to 5 flashes (excellent) – no flashing means the transceiver has not received a test signal from the **evohome** Controller.

- 4 To exit test mode press the button on the transceiver.

1



Configuration and modification

Once you've completed these steps you're ready to start using your **evohome** system. You can also make parameter adjustments in the **evohome** Controller to match the exact requirements of the heating system. The operation and functions of the each zone can also be adjusted. These can be found in the Installer Menu.

Components can be added or replaced by editing the zones or system in the Installer menu.

In this section

Parameters and control features	38
Configuring a zone with multiple rooms	38
Adding or replacing components in an existing system	39

Parameters and control features

Once you've completed these steps you're ready to start using evo. The user guide gives you instructions for personalising the settings on the **evohome** Controller.

You can also make parameter adjustments on your **evohome** Controller to match the exact requirements of the heating system. These can be found in the Installer Menu.

- 1 On the **evohome** Controller press and hold 'Settings' for 3 seconds
- 2 Press the green tick 
- 3 Press SYETEM PARAMETERS and choose the parameter you want to adjust:
 - Internal Sensor Offset
 - Cycle Rate
 - Minimum On Time
 - Fail Safe
 - Hot Water Parameters

For more details on parameters visit www.evohome.honeywell.com

Configuring a zone with multiple rooms



A multiple room zone does not support separate remote temperature sensors (such as DTS92).

Room temperature sensing is done by the radiator controllers.

evohome allows you to create a zone with multiple rooms (i.e. Bedroom's) that are controlled together as one group. It does this by letting all the radiator controllers bound to that zone to independently measure room temperature and control a radiator. This means you can locate the radiator controllers in separate rooms without them all being controlled by one temperature sensor like a single room zone does.

To create a multiple room zone either:

- Add a new zone and bind the radiator controllers for all the rooms. Go to the parameters menu and select multiple room zone.

or

- Go to Zone Configuration and edit an existing zone's parameters. Any bound radiator controllers already bound to that zone will now work independently
-

Adding or replacing components in an existing system



If the device you are replacing is no longer required in the system remove the power as it may still try to communicate with the system.

To add or replace a zone device such as a Radiator Controller or Temperature Sensor

- 1 On the **evohome** Controller press and hold "Settings" for 3 seconds
- 2 Press the green tick 
- 3 Press ZONE CONFIGURATION
- 4 Select the required zone
- 5 Press RF DEVICE BINDING then follow the instructions to bind the device.



If the device you are replacing is no longer required in the system remove the power as it may still try to communicate with the system.

To replace a system device such as a Wireless Relay Box, System Valve, or Hot Water component

- 1 On the **evohome** Controller press and hold "Settings" for 3 seconds
- 2 Press the green tick 
- 3 Press SYSTEM DEVICES
- 4 Select the type of device and follow the instructions to bind.

Appendix

Heating system schematics, Wiring diagrams

In this section

Sample evohome systems	42
Wiring diagrams	44
Safety information	48
evohome Controller technical data	49

Sample evohome systems

Figure 1 Single zone system

Single zone

The **evohome** Controller is the sensor for the whole home which is controlled to the same time and temperature schedule.

This system also includes wireless connectivity, which is available for any configuration.

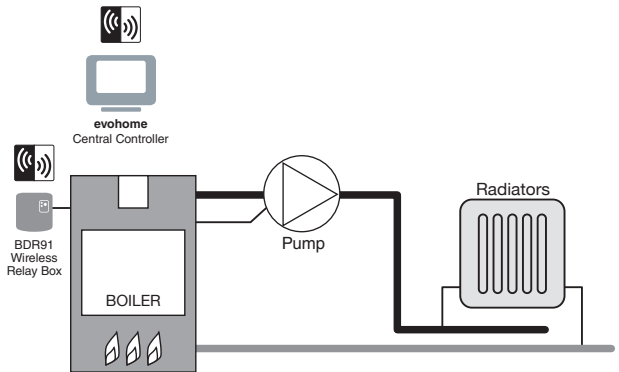



Figure 2 Honeywell S plan

Honeywell S plan 2 two-port valves

There are two zone valves – one for stored hot water one for central heating. The **evohome** Controller is the sensor for the whole home which is controlled to the same time and temperature schedule. The valves open when needed. The boiler is operated via a wired junction box.



If a system has been set up and the Wireless Relay Boxes are moved to a new function, the relay binding must be cleared or it will continue to carry out its original function.

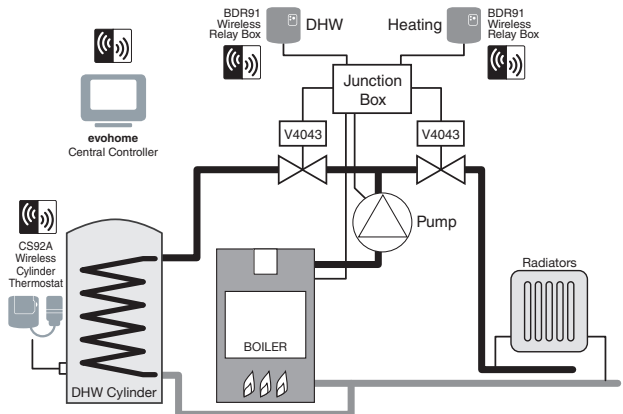

Figure 3 Honeywell Y plan

!
If a system has been set up and the Wireless Relay Boxes are moved to a new function, the relay binding must be cleared or it will continue to carry out its original function.

Honeywell Y plan 1 three-port mid-position valve

The operation is identical to the S plan but it uses a single three-port or mid position valve.

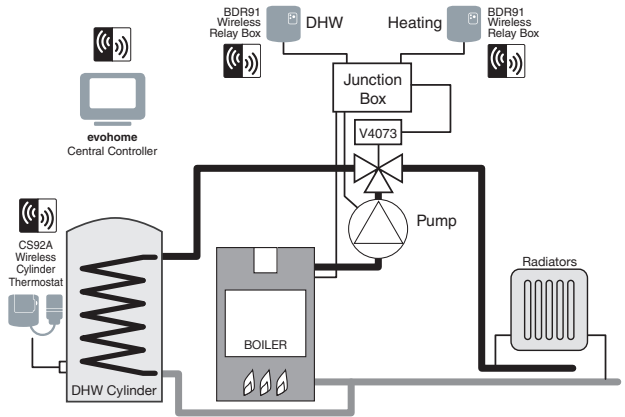
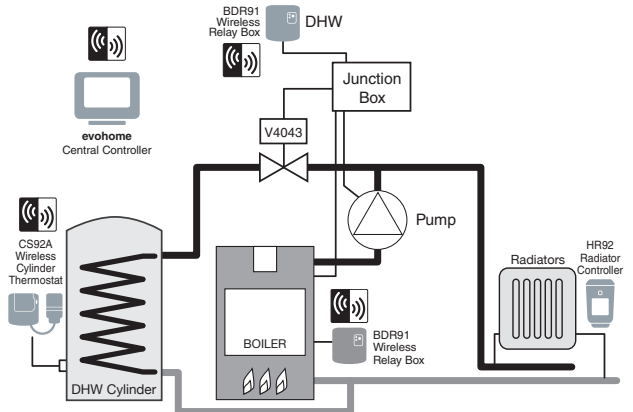

Figure 4 Stored hot water and zoned heating system. This system needs HR92s or other zoning solutions for the radiators.

!
If a system has been set up and the Wireless Relay Boxes are moved to a new function, the relay binding must be cleared or it will continue to carry out its original function.

Stored hot water and zoned heating



Wiring diagrams

Figure 5 Wiring for a basic boiler (not requiring a pump overrun). The relay powers the boiler live input.

Connecting a Wireless Relay Box to a: Basic boiler

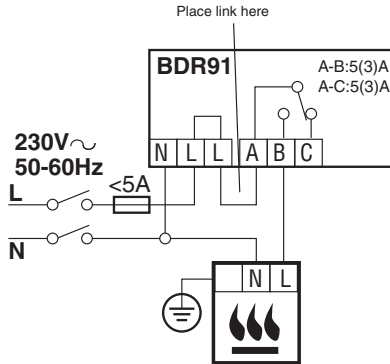

Figure 6 Boiler that requires a permanent live

Boiler that requires a permanent live

For use with boiler that require a permanent live (this is a typical Combi boiler wiring) but please check manufacturers instructions. This can be used for boilers with low voltage or 230vac room thermostat inputs.

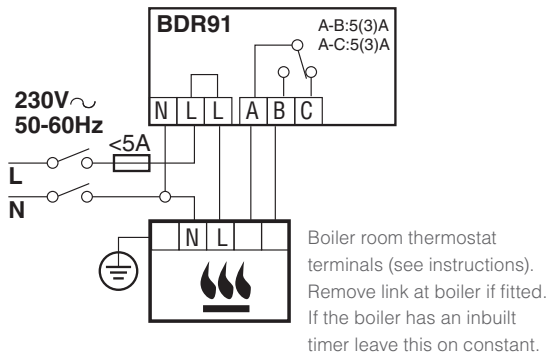
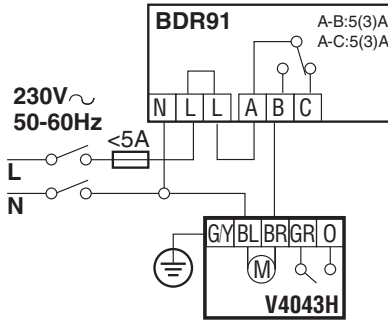

Figure 7 Connecting a two port zone valve

G/Y: Green/Yellow Earth wire
 BL: Blue Motor Neutral
 BR: Brown Motor Live
 GR: Grey End switch (if used) Permanent Live
 O: Orange End switch (If used). In wired system this typically feeds the boiler. When a wireless relay box is fitted the end switch is not required.

Two-port zone valve



!

If connecting a two port zone valve with an unvented cylinder connection for a high limit thermostat, the 'L' permanent live feed must be broken when high limit cutout activates on the insertion thermostat.

Connecting an Opentherm bridge

Figure 8 Wiring an OpenTherm Bridge to an OpenTherm boiler.

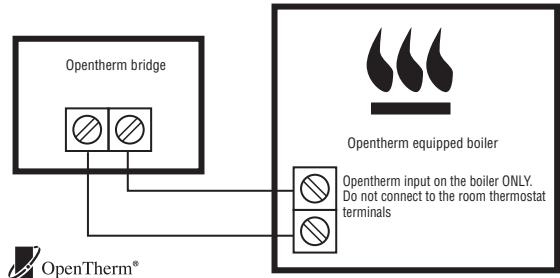

Wiring diagrams *continued*

Figure 9 Two port valves with a wired boiler. If a wireless boiler relay is used the Grey, Orange wire and feed to pump and boiler are not required.

Sundial or system valves

S Plan: 2 two-port valves with a wired boiler

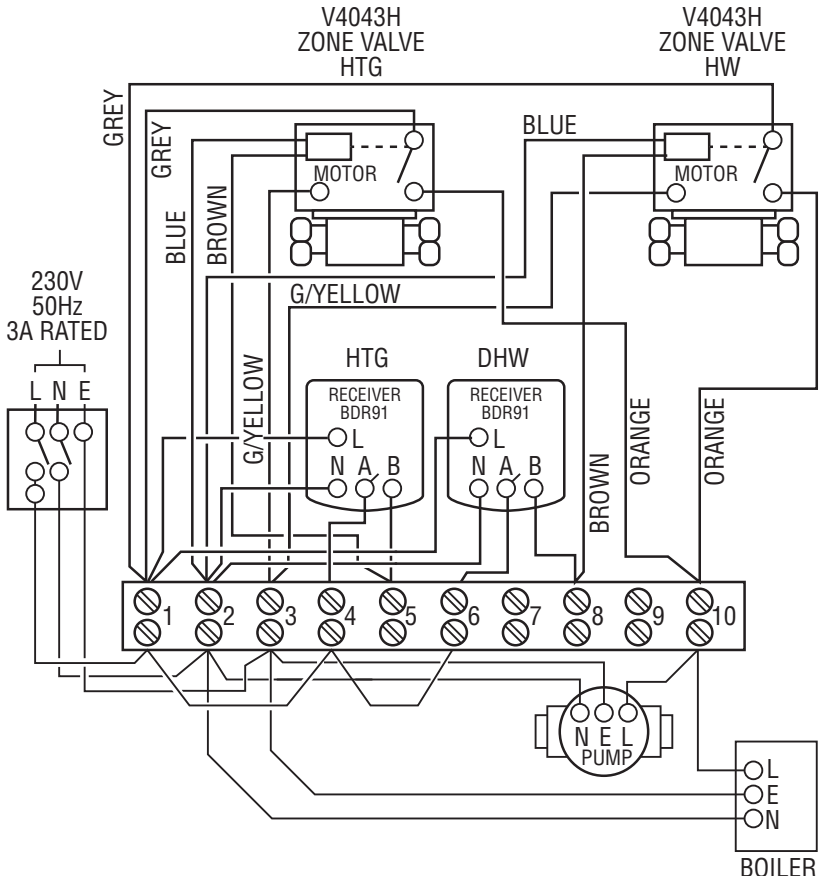
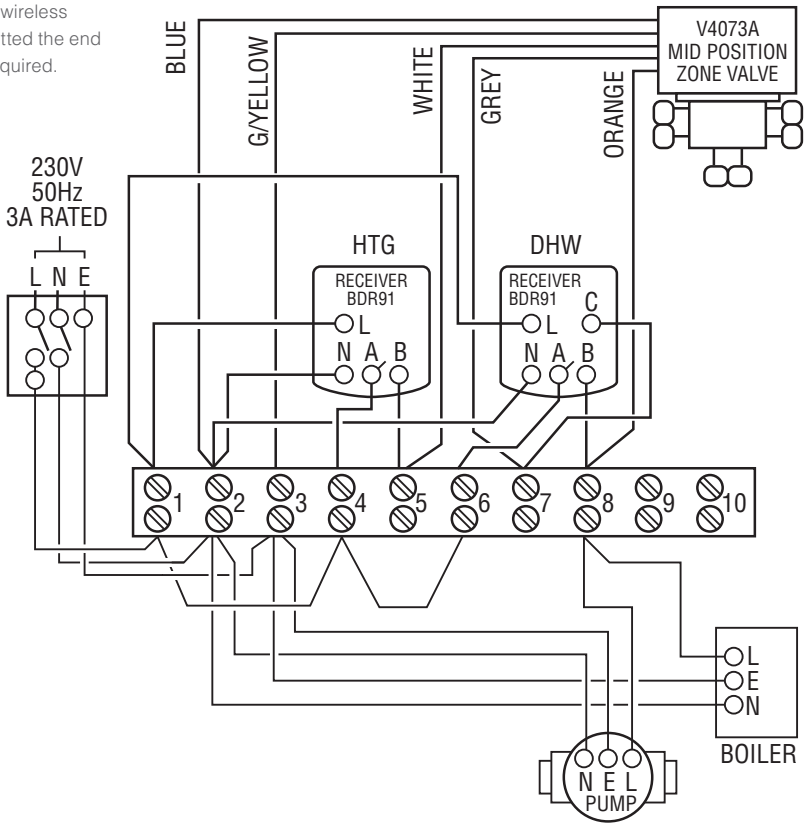

Figure 10 Mid position (3 port) valve

G/Yellow: Earth wire
 BLUE: Motor Neutral
 WHITE: Heating relay
 GREY: Hot water relay
 ORANGE: End switch (If used). In wired system this typically feeds the boiler. When a wireless boiler relay is fitted the end switch is not required.

Y Plan: Three-port Mid position valve with a wired boiler

If a wireless boiler relay is used the Orange wire and feed to pump and boiler are not required.



Safety information

Approvals

Conforms to protection requirements of the following directives:

EMC: 2004/108/EC

LVD: 2006/95/EC

R&TTE: 1999/05/EC

Hereby, Honeywell, declares that this **evohome** Controller is in compliance with the essential requirements and other relevant provisions of Directive 1999/5/EC.

EMC compliance considerations

Refer to Code of Practice standards EN61000-5-1 and -2 for guidance.

Caution: Isolate power supply and make safe before wiring the unit to prevent electric shock and equipment damage. Installation should be carried out by a competent person.

Location of device

evohome Controller should be installed in an open space for best performance as it is a radio frequency device. Leave at least 30cm distance from any metal objects including wall boxes and at least 1 metre from any other electrical equipment eg. radio, TV, PC etc. Do not mount onto metal wall boxes.

For the best temperature control performance the **evohome** Controller should not be placed near heat or cool sources (e.g. cooker, lamp, radiator, doorways, windows).

Disclaimer

This product and its associated documentation and packaging are protected by various intellectual property rights belonging to Honeywell Inc and its subsidiaries and existing under the laws of the UK and other countries. These intellectual and property rights may include patent applications, registered designs, unregistered designs, registered trademarks, unregistered trademarks and copyrights.

Honeywell reserves the right to modify this document, product and functionality without notice. This document replaces any previously issued instructions and is only applicable to the product(s) described.

This product has been designed for applications as described within this document. For use outside of the scope as described herein, refer to Honeywell for guidance. Honeywell cannot be held responsible for misapplication of the product(s) described within this document.

PLEASE RESPECT YOUR ENVIRONMENT!

Take care to dispose of this product and any packaging or literature in an appropriate way.



WEEE directive 2012/19/EU

Waste Electrical and Electronic Equipment directive

- At the end of the product life dispose of the packaging and product in a corresponding recycling centre.
- Do not dispose of the unit with the usual domestic refuse.
- Do not burn the product.
- Remove the batteries.
- Dispose of the batteries according to the local statutory requirements and not with the usual domestic refuse.

evohome Controller technical data

Electrical

Table Stand Power supply	Input voltage: 100-240V~ 50/60Hz 0.2A Output voltage: +5V --- 1A
Wall Bracket Power supply	Input voltage: 230VAC ±10% Output voltage: 4VDC ±0.2V, max 2.6W
Room unit power supply input	5V --- ±0.2V, max. 2.6W
Low voltage cable length (max)	10m, 1.0mm ² ; 5m, 0.5mm ²
Battery type (rechargeable)	Type AA 1.2V NiMH 2000-2400mAh

RF Communication

RF operation band	ISM (868.0—870.0) MHz, RX Class 2
RF communication range	30m in a residential building environment
Wireless LAN	IEEE 802.11b,g,n (2.400-2.485 GHz)

Environmental and Standards

Operating temperature	0 to 40°C
Storage temperature	-20 to +50°C
Humidity	10 to 90% relative humidity non condensing
IP Protection Class	IP30

Mechanical

Dimensions	136 x 93 x 20mm (WxHxD)
------------	-------------------------

evohome is designed to convert a system with single zone pipework into a multi zone system, resulting in optimal control and comfort combined with maximum energy saving.

For more information on Smart Heat Zoning for your home, visit:

www.evohome.honeywell.com



Manufactured for and on behalf of the Environmental and Combustion Controls Division of Honeywell Technologies Sàrl, ACS-ECC EMEA, Z.A. La Pièce 16, 1180 Rolle, Switzerland by its Authorised Representative Honeywell Inc.

Honeywell Control Systems Ltd.

Skimped Hill Lane,

Bracknell

Berkshire

RG12 1EB

www.honeywelluk.com

 **AutomatikCentret**

Strandvejen 42 ♦ Saksild ♦ 8300 Odder

86 62 63 64 ♦ www.automatikcentret.dk

info@automatikcentret.dk

32303494-001 A

© 2014 Honeywell International Inc.